

Making a Tricking car

(S) : short
(M) : middle
(L) : long

1

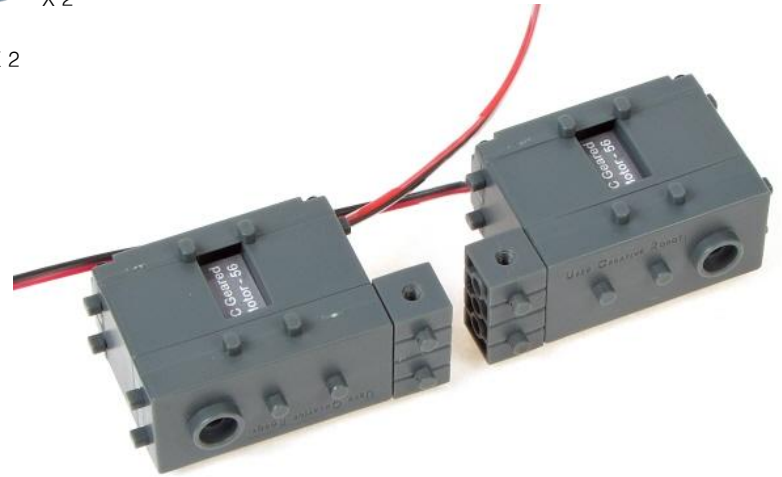

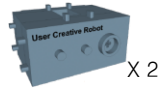

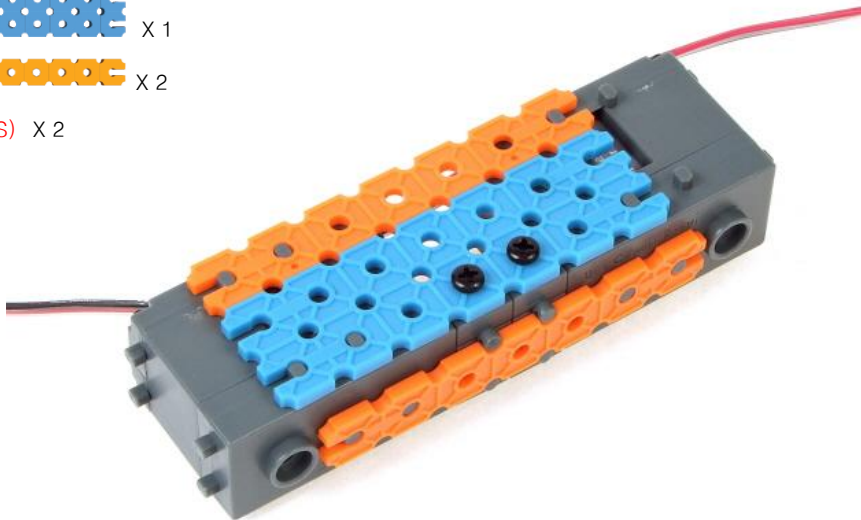
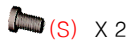
2

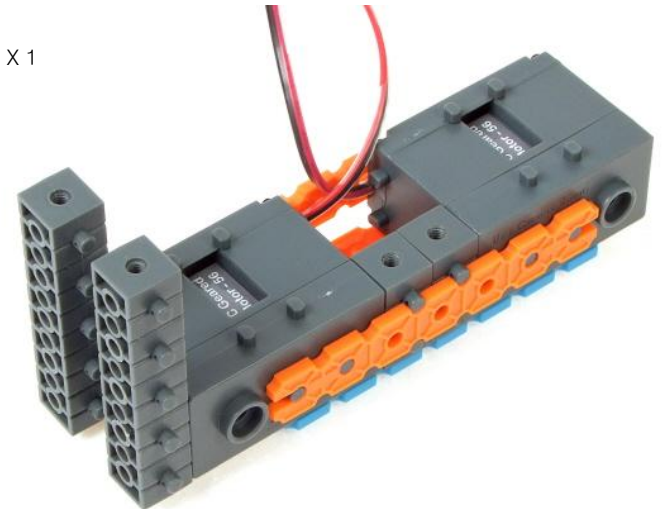

3





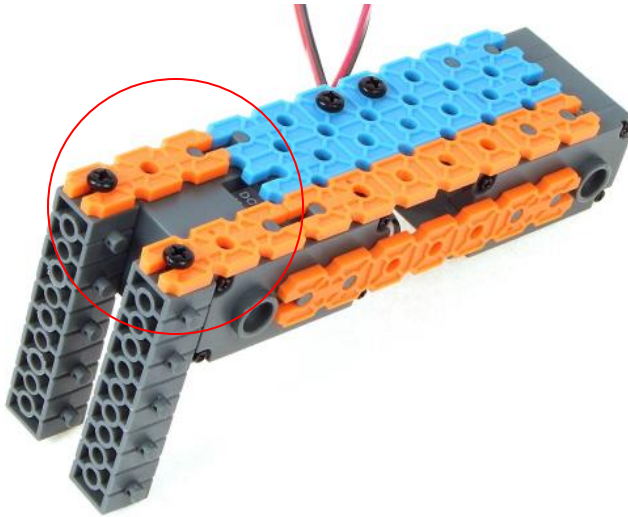

4

-  X 2
-  (S) X 2

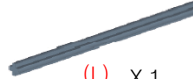

5

-  (L) X 1
-  X 1
-  X 1
-  (S) X 2

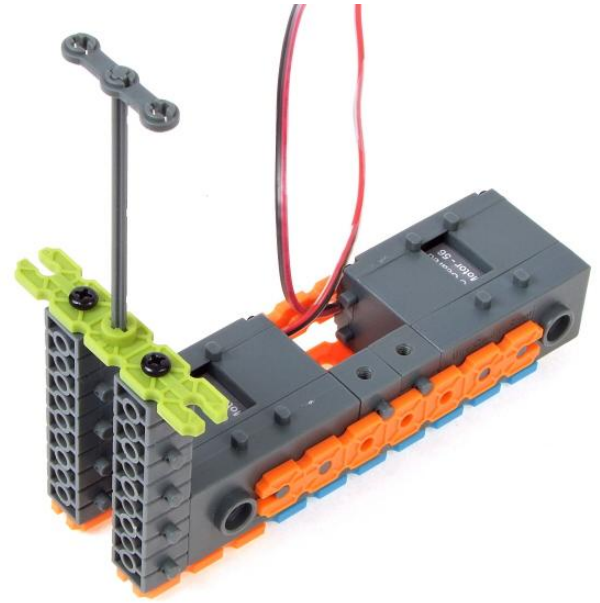

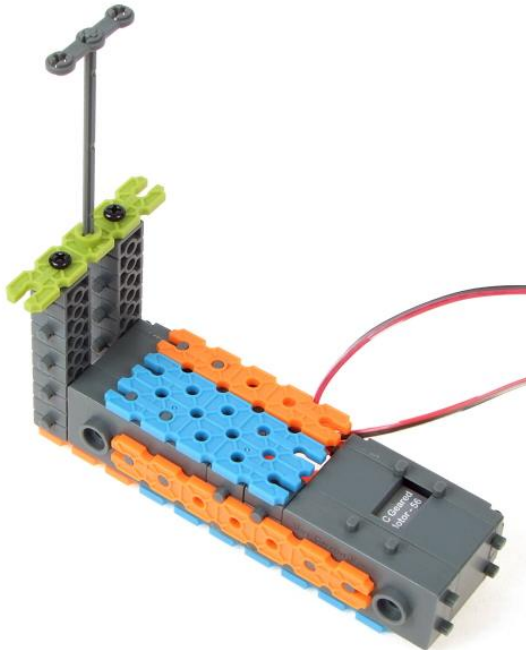

6

-  X 1
-  X 1



7



-  X 2
-  X 2
-  (S) X 4

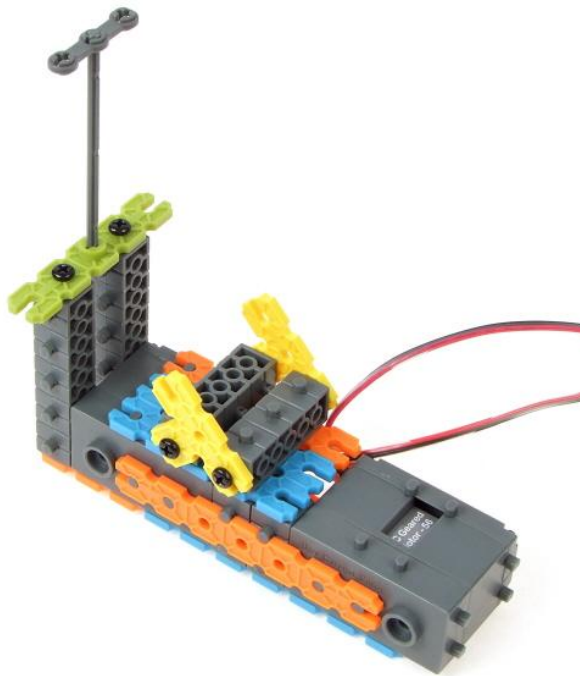

8



9



-  X 2
-  X 2
-  (S) X 2

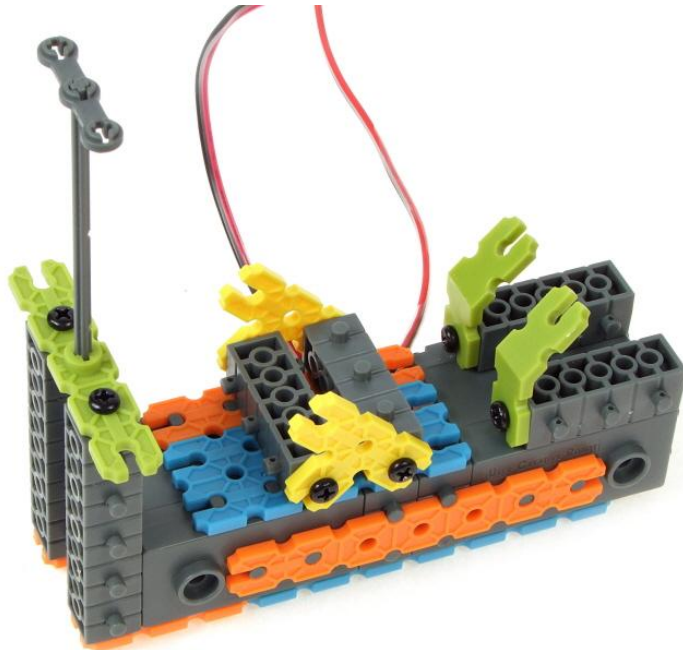

10



11

-  X 2
-  (S) X 2

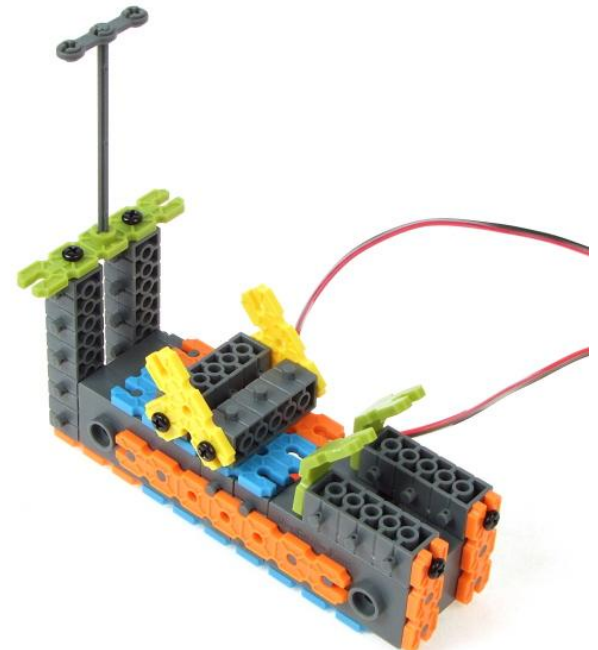

12

- X 2
- X 2
- X 2
- X 2



13

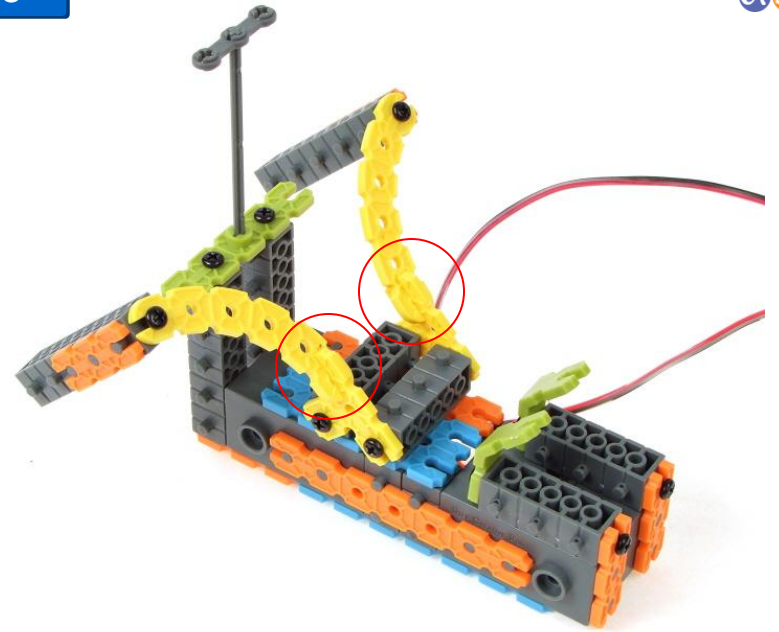

14

- Motor axis X 1
- X 1

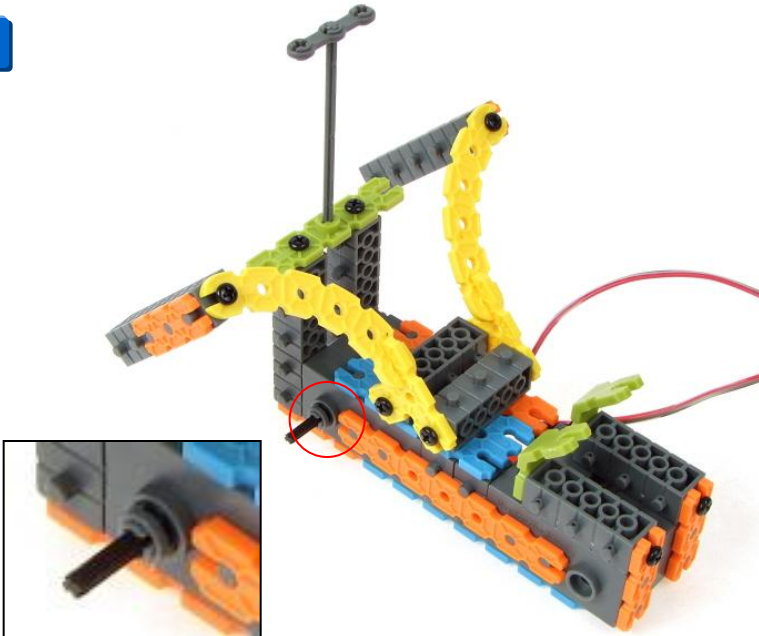

15

- X 1

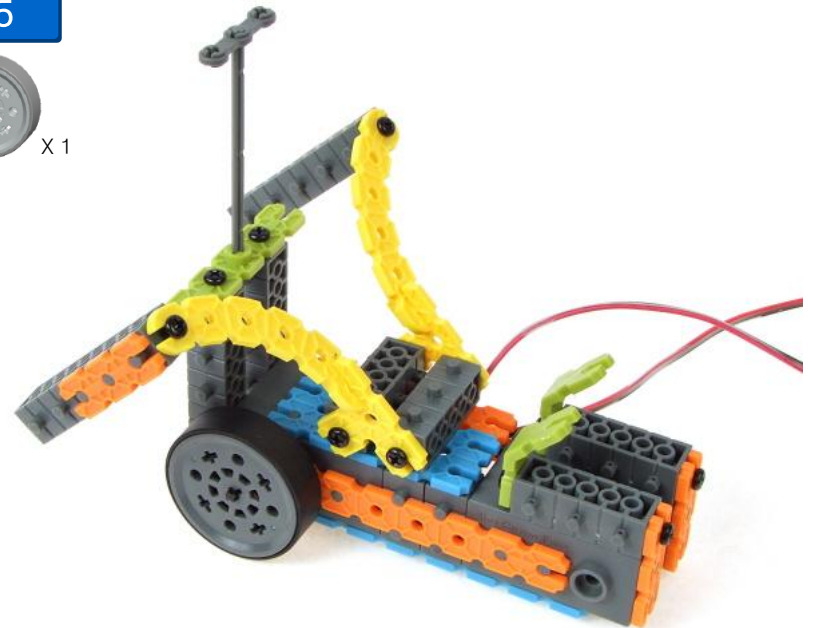

16



X 1



Motor axis X 1



X 1

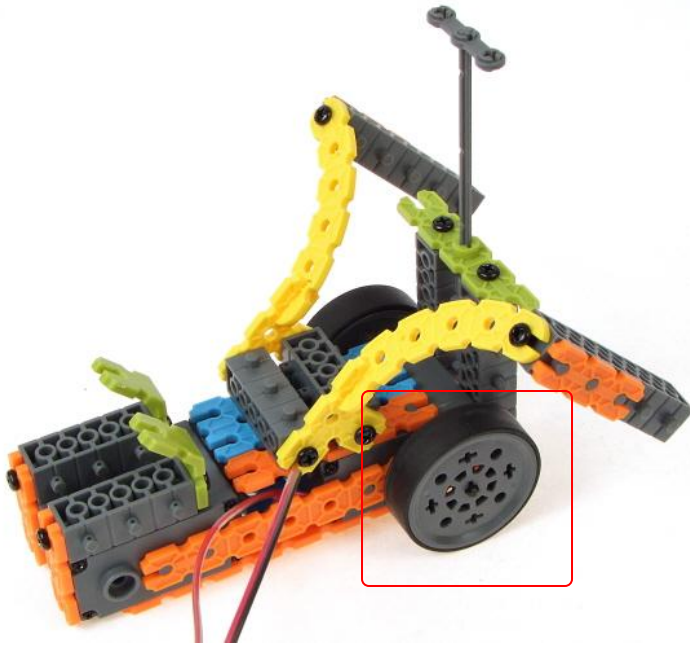

17



Motor axis X 1

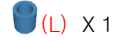

(L) X 1



18

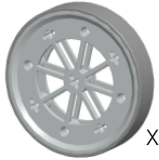

X 1

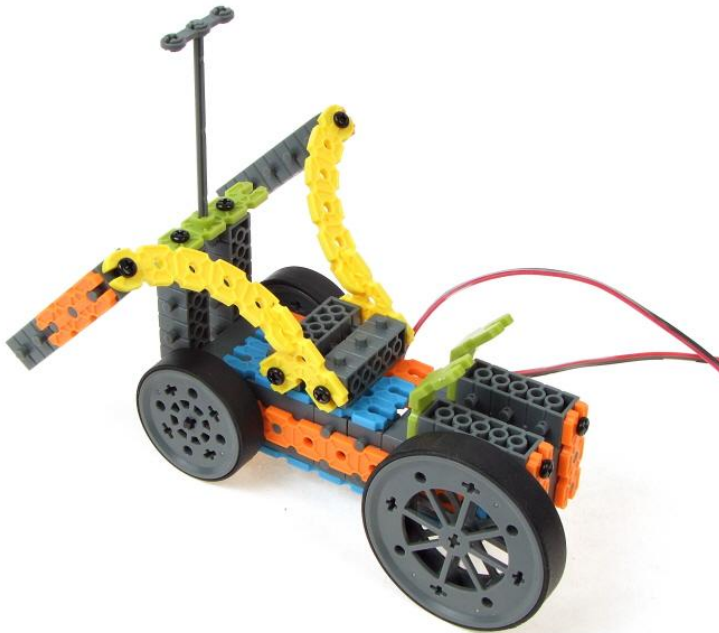

19

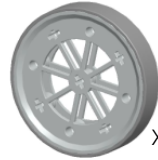

X 1



Motor axis X 1

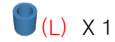

(L) X 1

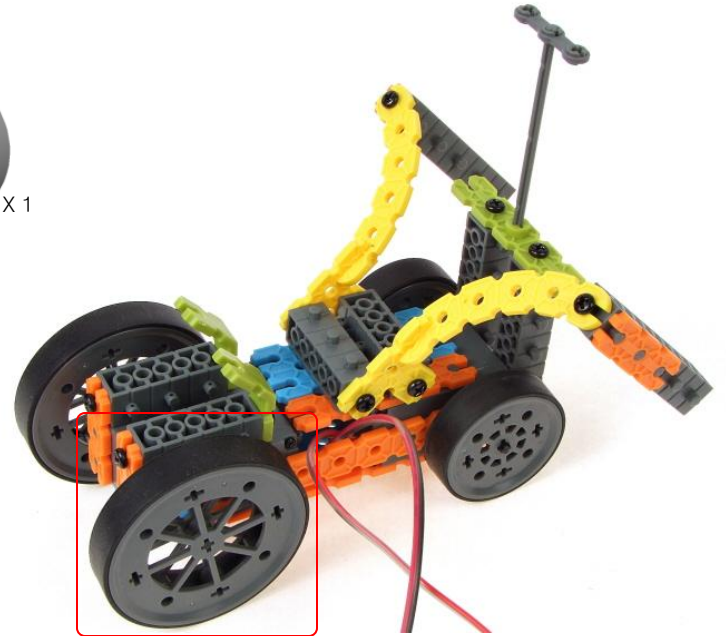

20



X 1



X 2



X 2



21



Servo motor X 1



X 1

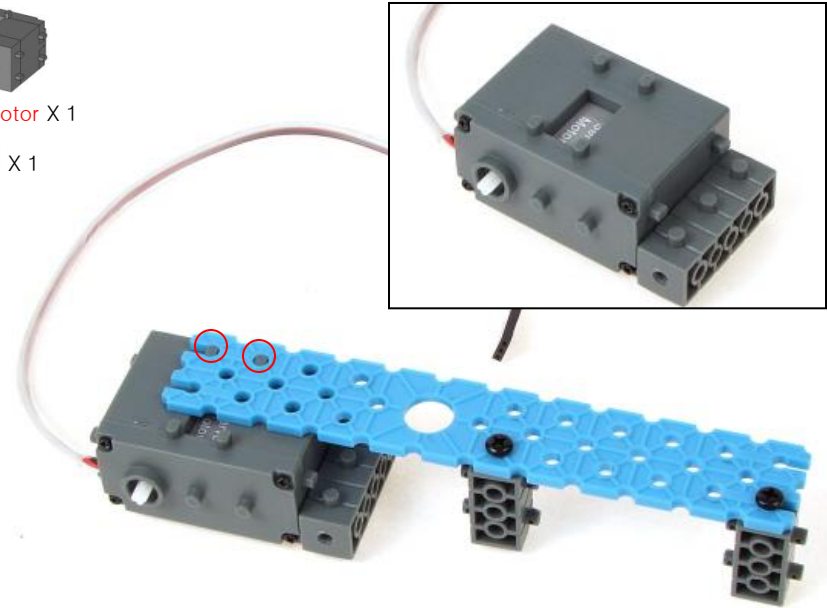

22



X 1

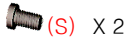

X 2

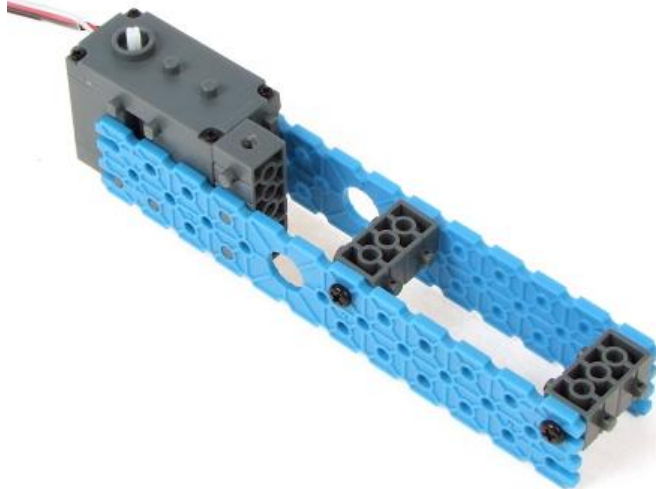

23



X 1



X 1







X 2

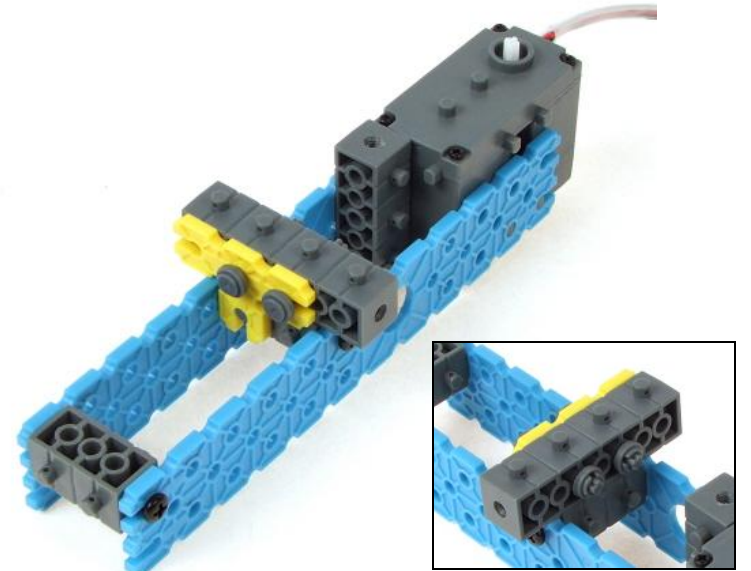

X 2



24

-  X 1
-  X 1
-  X 2
-  X 2

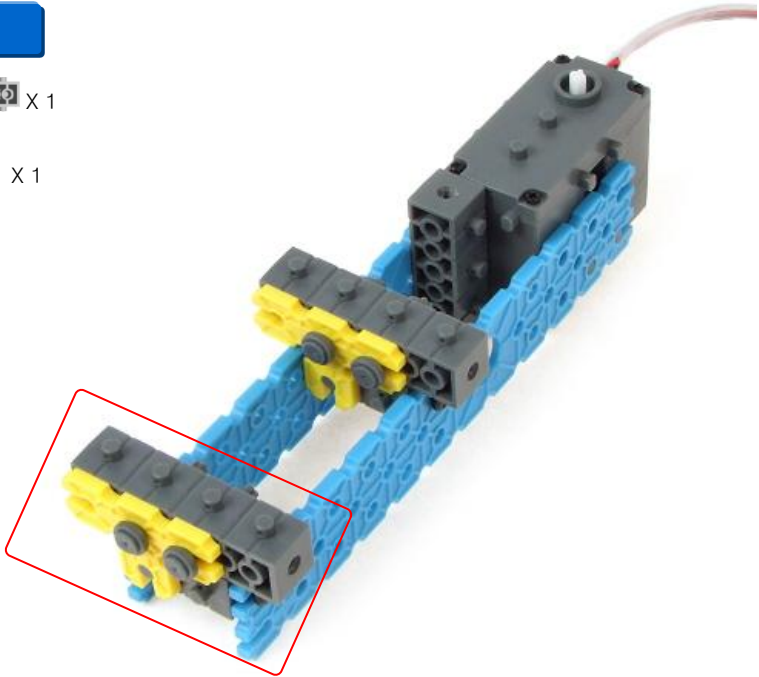



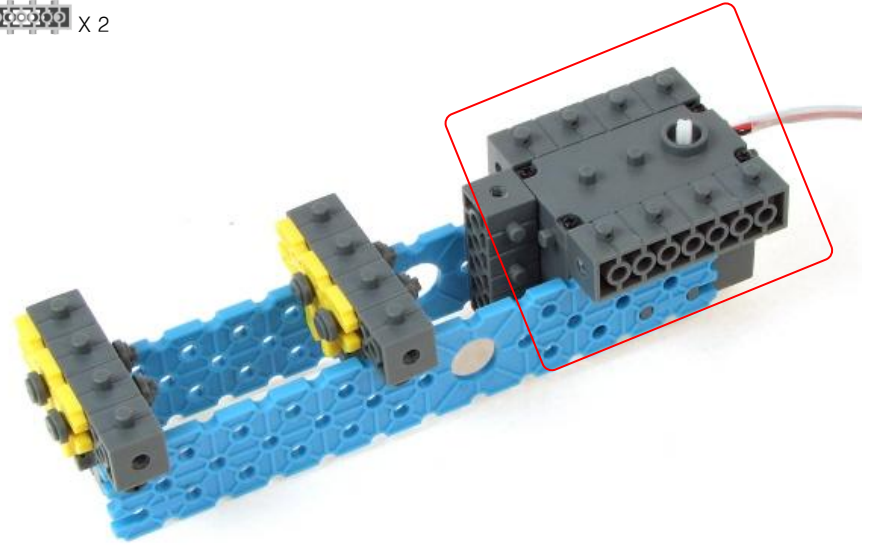

25

-  X 2



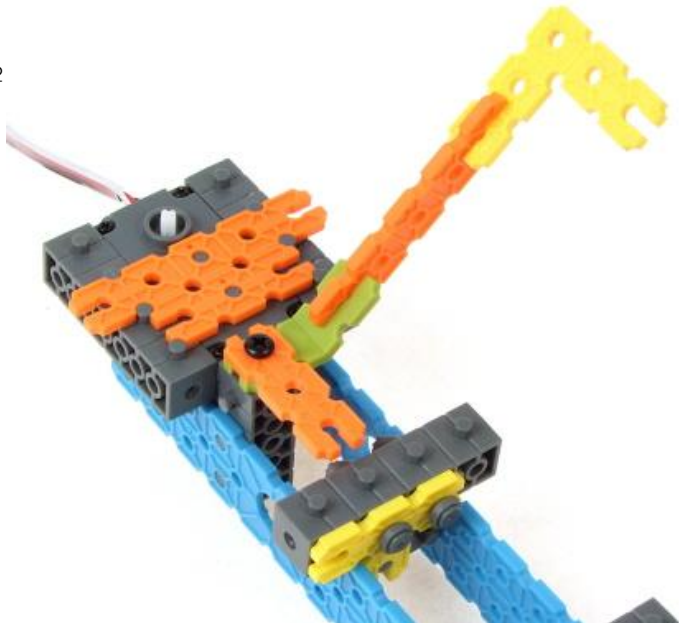

26

-  X 2
-  X 2
-  X 1
-  X 1
-  (L) X 1



27

-  X 2
-  (S) X 2

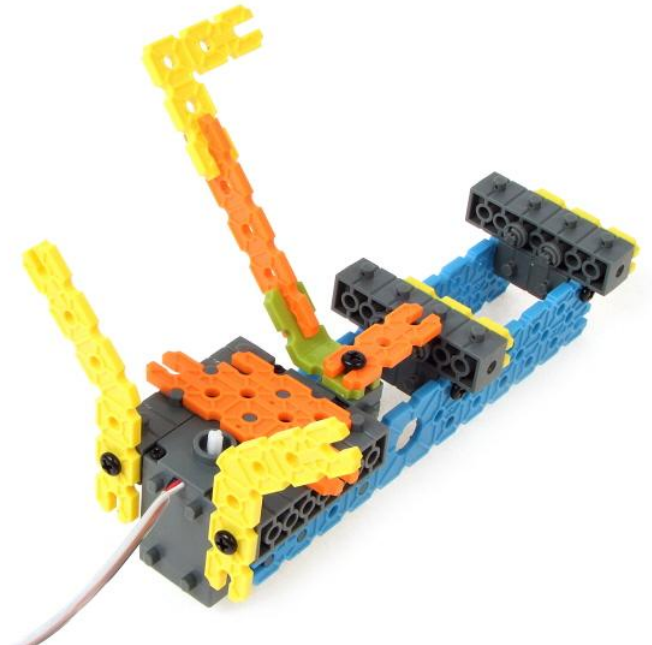

28



X 1



X 1



29



X 2



X 2



30



X 2



X 1



X 2



31



X 2



X 1



X 2



32

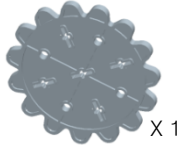

X 1



X 15



X 15



33

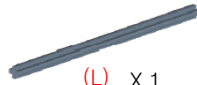

(L) X 1



X 1



X 1



X 1



(S) X 1



34



X 1



X 1



X 1

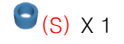

(S) X 1



35



36

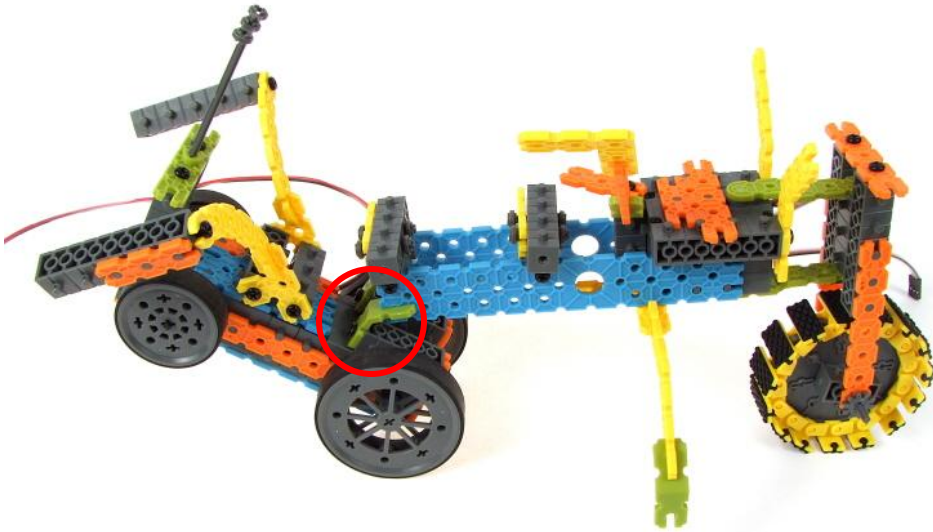

37



LED (G) X 1



LED (R) X 1

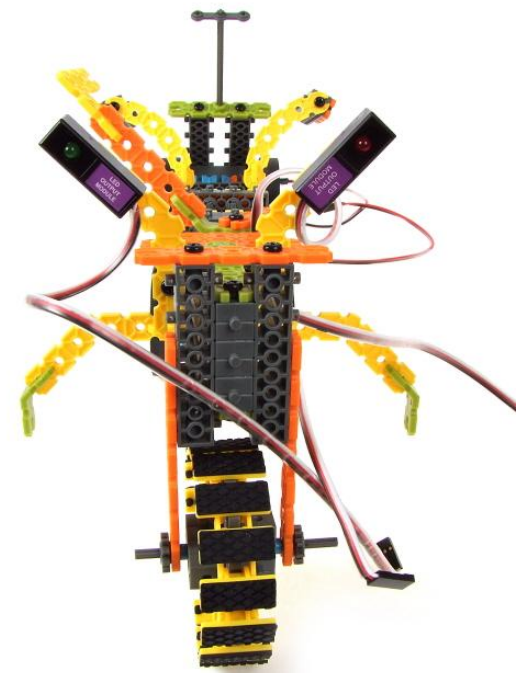

38



Remote control receiver X 1

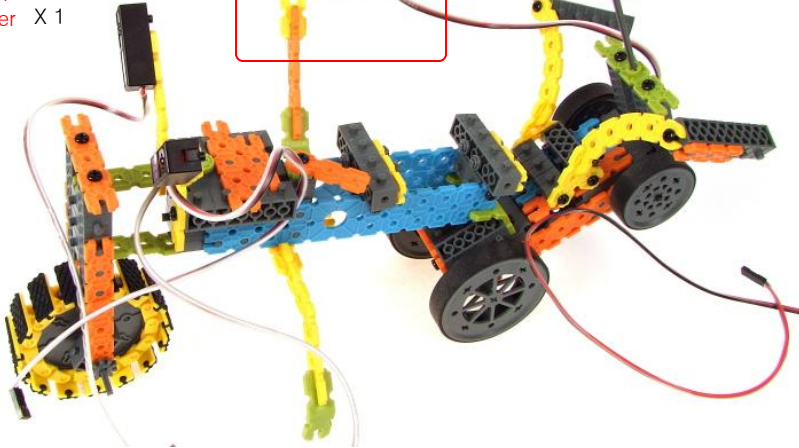
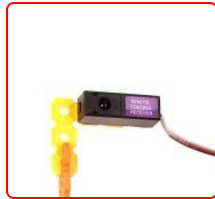

39



X 1

Fix the mainboard.

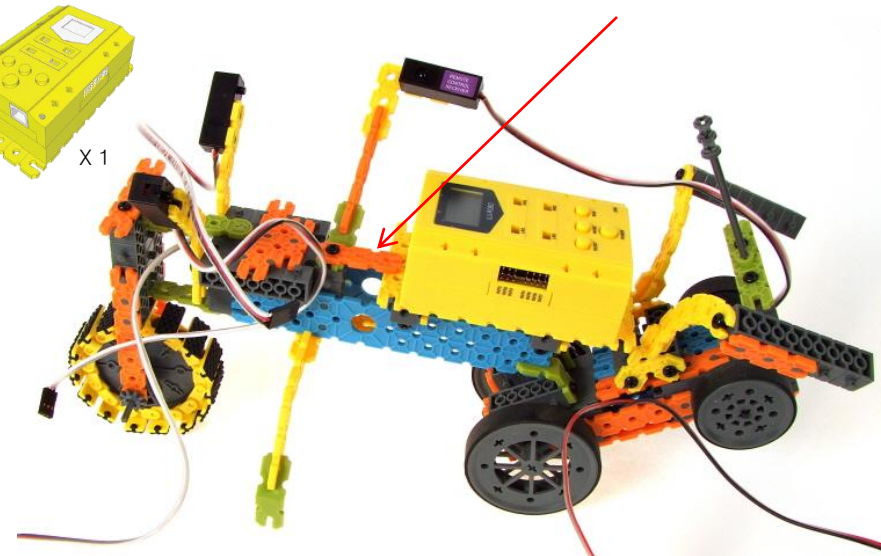

END

Front side DC motor – Right DC motor
 Rear side DC motor – Left DC motor

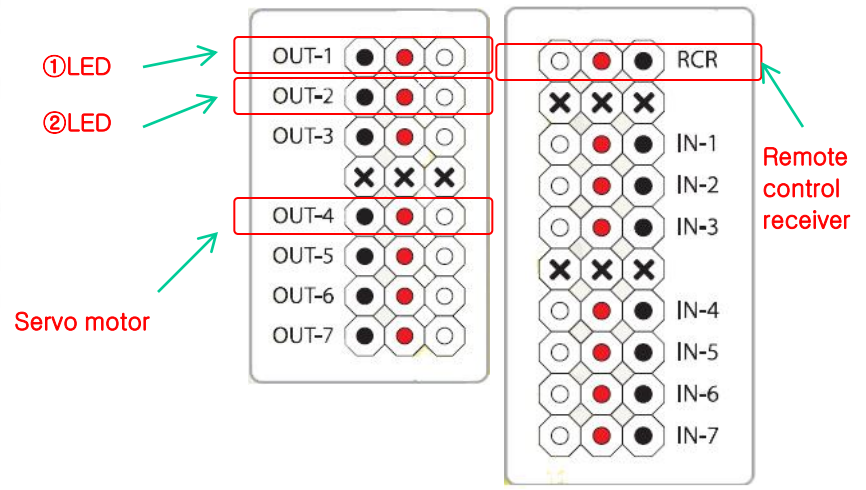
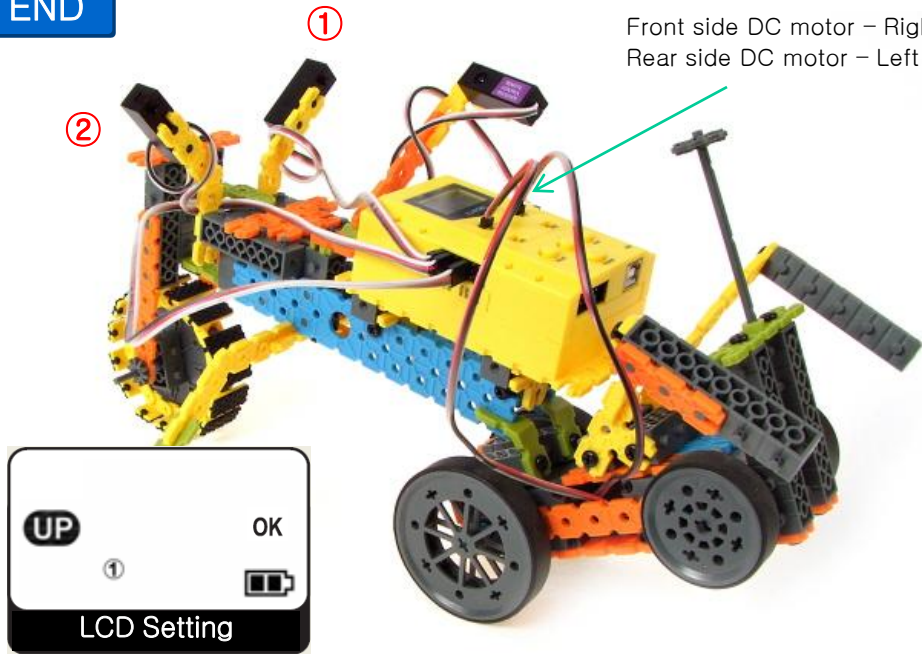

Decorating robot !

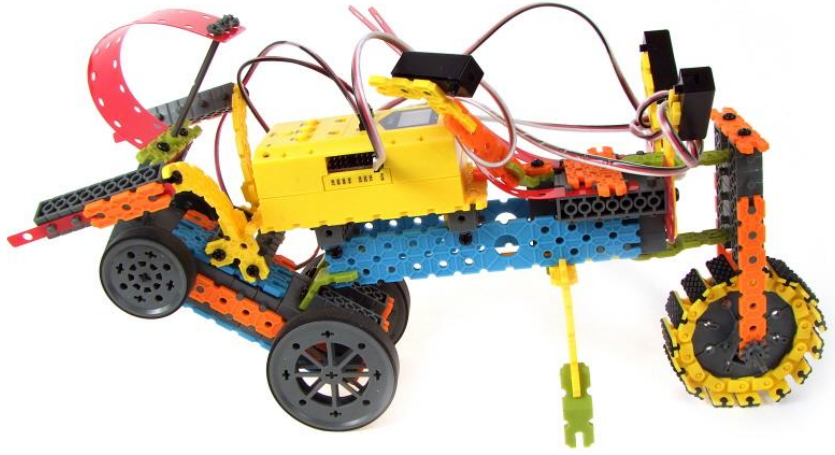
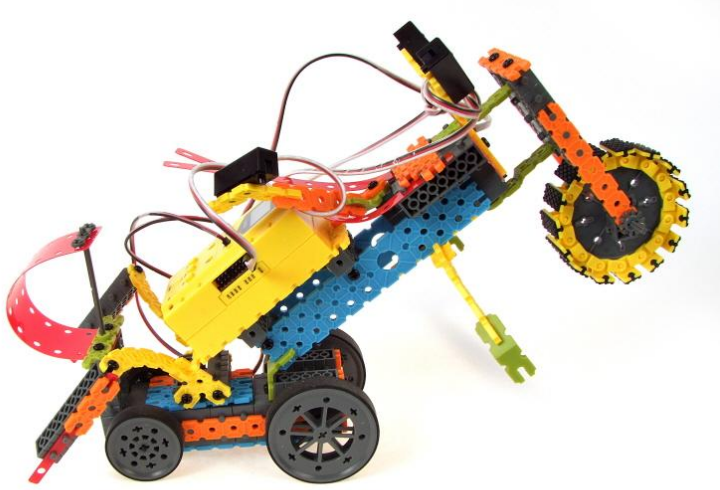

Part List of a Tricking Car



X 2



X 5



X 1



X 4



X 1



X 1



X 4



X 2



X 2



X 1



X 8



X 5



X 1



X 4



X 1



X 4

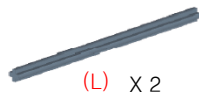

(L) X 2

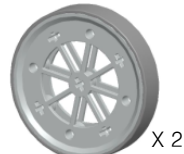

X 2



(L) X 1



Servo motor X 1



Remote control receiver X 1



X 4



X 1

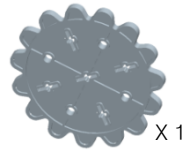

X 1

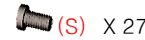

(S) X 27



X 2



LED(G) X 1



X 6



X 4



X 2



(L) X 2



Motor axis X 4



LED(R) X 1



X 6



X 15



(S) X 2



X 15



X 6



X 2